

Art. nr. 91017455

Omschrijving: Z05-anker 170x43x88 60x8 (sprong 35mm)

Materiaal: S355

Behandeling: Thermisch verzinkt

Verpakkinghoeveelheid: 1 st.

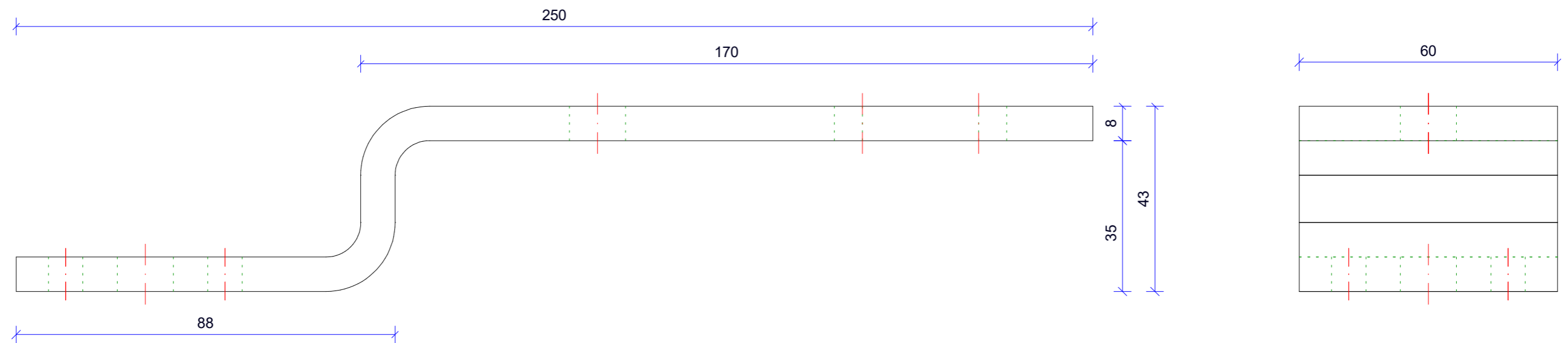
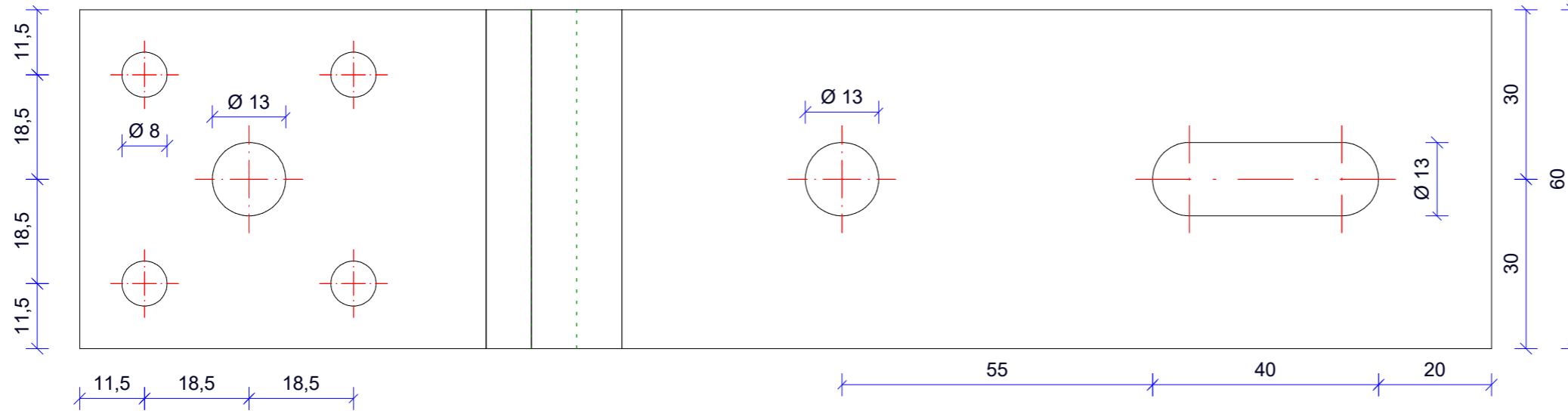
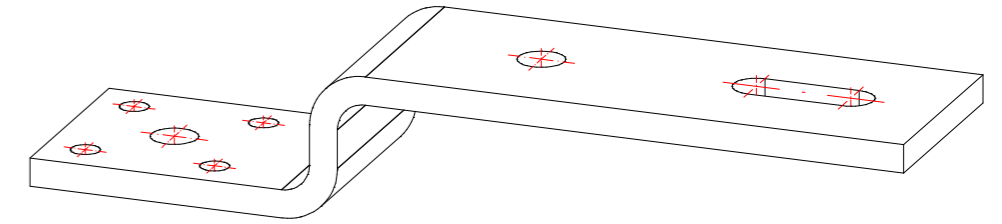

E-mail: verkoop@jonkers-bouwmetaal.nl

Adres: Hoornse Hop 10, 8321 WX Urk

Telefoon: 0527-685156

Website: www.jonkers-bouwmetaal.nl

